

Original Instructions



Cube M

LaserDiagnosticsSoftware LDS

Cube App

IMPORTANT!
READ CAREFULLY BEFORE USE.
KEEP FOR FUTURE USE.

Table of contents

1	Basic safety instructions	8
2	Symbol explanation	10
3	About this operating manual	11
4	Conditions at the installation site	11
5	Important notes on the lithium-ion battery	12
5.1	Charging the lithium-ion battery	12
5.2	Storing the device with a permanently installed lithium-ion battery.....	12
5.3	Dangers to health and the environment in the event of damage to the lithium-ion battery	12
5.4	Shipping the device with permanently installed lithium-ion battery	12
6	Device description	13
6.1	Functional description	13
6.2	Measuring principles	13
7	Transport	14
8	Installation/Removal	15
8.1	Prepare installation.....	15
8.2	Mounting position	15
8.3	Align the device	16
8.3.1	Align the device with the alignment tool.....	17
8.4	Install the device	18
8.5	Remove the device	18
9	Connections	19
9.1	Safety interlock	19
9.2	Micro-USB socket	20
9.3	Bluetooth	21

10	Functions of the On/Off button	21
11	Displays on the device	22
11.1	Status messages	22
11.2	Warning message	23
11.3	Charge status of the lithium-ion battery	23
12	Important information for measuring with the Cube M	24
12.1	Safety instructions	24
12.2	Laser parameter setting	26
12.2.1	Setting the laser rise time	26
12.2.2	Maximum permissible power density	27
12.2.3	Minimum and maximum energy input per measurement	28
12.3	Waiting times until the next measurement in a measurement series	29
12.4	Measurement with pulsed lasers	30
13	Measuring with the Cube M	31
13.1	Start measurement	31
13.2	Measuring results display	33
14	Measuring with the optional LaserDiagnosticsSoftware LDS	34
14.1	Notes of the LaserDiagnosticsSoftware LDS during measurement	34
14.2	Connect the Cube M to the LaserDiagnosticsSoftware LDS	35
14.3	Open toolbench Cube measurement	36
14.4	Settings for trigger level, power saving functions and automatic measurement readiness	37
14.5	Start measurement	39
14.6	Measuring results display	40
14.6.1	Display the current measurement in the toolbench Cube measurement	40
14.6.2	Display of the measurements stored in the Cube M	41
14.7	Delete measured values from the memory of the Cube M	43

15	Measuring with the optional Cube App	44
16	Maintenance and service	45
16.1	Exchanging the protective window on the device	45
16.1.1	Safety instructions	45
16.1.2	Exchanging the protective window	47
17	Measures for the product disposal	48
18	Declaration of conformity	49
19	Technical data	50
20	Dimensions	52

PRIMES - The Company

PRIMES manufactures measuring devices used to analyze laser beams. These devices are employed for the diagnostics of high-power lasers ranging from CO₂ lasers and solid-state lasers to diode lasers. A wavelength range from infrared through to near UV is covered, offering a wide variety of measuring devices to determine the following beam parameters:

- Laser power
- Beam dimensions and position of an unfocused beam
- Beam dimensions and position of a focused beam
- Beam quality factor M^2

Development, production and calibration of the measuring devices is performed at PRIMES. This guarantees optimum quality, excellent service, and a short reaction time, providing the basis for us to meet all of our customers' requirements quickly and reliably.



PRIMES GmbH
Max-Planck-Str. 2
64319 Pfungstadt
Germany

Tel +49 6157 9878-0
info@primes.de
www.primes.de

1 Basic safety instructions

Intended use

The device has been designed exclusively for measurements in the beam of high-power lasers.

Use for any other purpose is considered as not intended and is strictly prohibited. Furthermore, intended use requires that you observe all information, instructions, safety notes and warning messages in this operating manual. The specifications given in chapter 19, „Technical data“, on page 50 apply. Any given limit values must be complied with.

If not used as intended, the device or the system in which the device is installed can be damaged or destroyed. In addition, there is an increased risk to health and life. Only use the device in such a way that there is no risk of injury.

If you still have questions after reading this operating manual, please contact PRIMES or your supplier for your own safety.

Observing applicable safety regulations

Observe the safety-relevant laws, guidelines, standards and regulations in the current editions published by the state, standardization organizations, professional associations, etc. In particular, observe the regulations on laser safety and comply with their requirements.

Necessary safety measures

The device measures direct laser radiation, but does not emit any radiation itself. However, during the measurement the laser beam is directed at the device. This produces scattered or directed reflection of the laser beam (laser class 4). The reflected beam is usually not visible.

Protect yourself from direct and reflected laser radiation while working with the device by taking the following measures:

- If the device is moved from its aligned position, increased scattered or directed reflection of the laser beam occurs during measuring operation. Fix the device in such a way that it cannot be moved by unintentional bumping or pulling on the cables.
- Connect the laser control's safety interlock to the device. Check that the safety interlock will switch off the laser properly in case of error.

- Install safety switches or emergency safety mechanisms that allow the laser to be switched off immediately.
- Use suitable beam guidance and beam absorber elements which do not emit any hazardous substances when irradiated.
- Wear **safety goggles** adapted to the power, power density, laser wave length and operating mode of the laser beam source in use.
- Wear suitable **protective clothing** or **protective gloves** if necessary.
- If possible, also protect yourself from direct laser radiation and scattered radiation by using separating protective devices that block or attenuate the radiation.

Employing qualified personnel

The device may only be operated by qualified personnel. The qualified personnel must have been instructed in the installation and operation of the device and must have a basic understanding of working with high-power lasers, beam guiding systems and focusing units.

Conversions and modifications

The device may not be modified in terms of design or safety without the express consent of the manufacturer. The same applies to unauthorised opening, dismantling and repair. The removal of covers is only permitted within the scope of the intended use.

Liability disclaimer

Manufacturer and distributor exclude any liability for damages and injuries which are direct or indirect consequences of using the device not as intended or modifying the device or the associated software without authorization.

2 Symbol explanation

The following symbols and signal words indicate possible residual risks:



DANGER

Means that death or serious physical injuries **will** occur if necessary safety precautions are not taken.



WARNING

Means that death or serious physical injuries **can** occur if necessary safety precautions are not taken.



CAUTION

Means that a slight physical injury **can** occur if necessary safety precautions are not taken.

NOTICE

Means that property damages **can** occur if necessary safety precautions are not taken.

The device itself or the packing bears the following symbols to indicate requirements and possible dangers:



Read and observe the operating instructions and safety guidelines before startup!



The device contains a permanently built-in lithium-ion battery. To avoid health and environmental damage, the battery must be disposed of in accordance with the applicable national and international laws.

Further symbols that are not safety-related:



Here you can find useful information and helpful hints.



With the CE marking the manufacturer guarantees that his product is in conformity with the EC guidelines.



Call for observing (visual feedback from the device or the software).



Call for action

3 About this operating manual

This documentation describes the installation and operation of the Cube M and performing measurements with the Cube M, the Cube App or the optional LaserDiagnosticsSoftware LDS.

With the Cube App for mobile devices with Android™ you can operate and evaluate the device via a smartphone/tablet. The Cube App is available for free in Google Play-Store/ Apps.

For measurement operation with a PC, the LaserDiagnosticsSoftware LDS (option) must be installed on the PC. For a detailed description of the software installation, file management and evaluation of the measured data, please refer to the separate operating manual LaserDiagnosticsSoftware LDS.

4 Conditions at the installation site

- The device must not be operated in a condensing atmosphere.
- The ambient air must be free of organic gases.
- Protect the device from splashes of water and dust.
- Operate the device in closed rooms only.

In industrial environments erroneous measurements may be triggered by strong electromagnetic fields. In this case we recommend EMC compliant shielding of the safety interlock cable.

5 Important notes on the lithium-ion battery

The device is equipped with a permanently installed rechargeable battery. Be aware that this battery may ignite at high temperatures. For operation, storage and shipping, refer to the information according to chapter 19, „Technical data“, on page 50.

5.1 Charging the lithium-ion battery

Charge the battery completely before using it for the first time. The first complete charge on the PC requires approx. 4 hours. Only use the supplied USB cable to charge the battery. Recharge the battery when the charge level reaches 20 percent. Do not charge the rechargeable battery unattended, e.g. overnight. Do not expose the device to direct sunlight.

5.2 Storing the device with a permanently installed lithium-ion battery

Store the device in a cool, dry place. Keep a minimum distance of 3 m from combustible materials. Do not expose the device to direct sunlight. Please charge the battery at least every three months.

5.3 Dangers to health and the environment in the event of damage to the lithium-ion battery

In general, contact with leaking battery components may pose a risk to health and the environment. Do not open the device to replace or dismantle the battery:

- When the battery is damaged, fluids (electrolytes) may leak out. These are flammable, contact with the eyes or skin may cause irritation.
- Vapors may irritate the eyes, respiratory organs, and skin.
- Fire or intense heat may cause violent bursting. Heating or fire may release toxic gases. Burning produces irritating smoke.

5.4 Shipping the device with permanently installed lithium-ion battery

The device with a permanently built-in battery is a dangerous good in case of shipment and is classified as “lithium ion batteries contained in equipment”. Particularly in the case of a damaged battery, special regulations must be observed. Please observe the requirements for shipping according to the valid regulations.

6 Device description

6.1 Functional description

With its compact dimensions, the device is used in the narrow conditions of laser systems for power measurement. Normally, the device is positioned underneath the focus position of the beam path. If this is not possible, the device can be positioned above the focus.

The laser beam passes through the protective glass and hits the absorber, where the temperature is recorded. The display shows the measured laser power and further information on the status of the device.

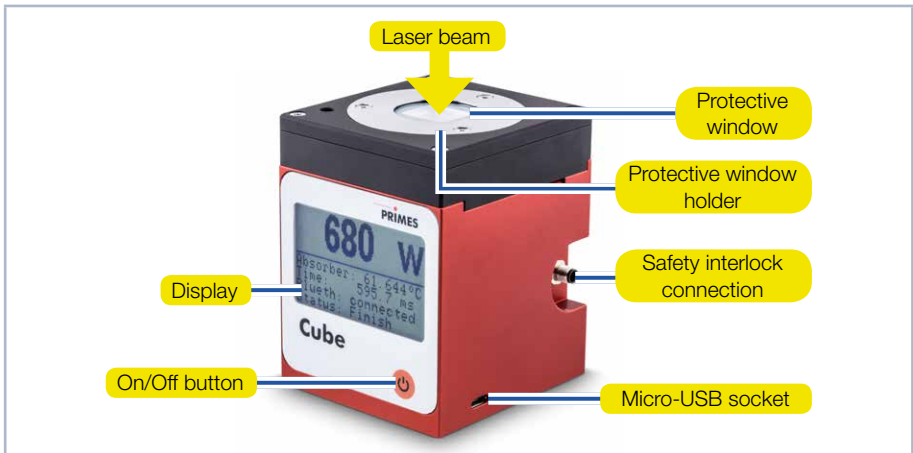

Fig. 6.1: Functional description

6.2 Measuring principles

The device measures the laser power according to the calorimetric principle. The absorber of the device is irradiated with the laser for a short period of time. The temperature of the absorber is recorded at the beginning and end of the irradiation. Based on the temperature rise and the thermal properties of the absorber, the microprocessor-based electronics are able to calculate the laser power with high accuracy.

7 Transport

NOTICE

Damaging/Destruction of the device

Hard impacts or dropping the device can damage the optical and electrical components.

- ▶ Handle the device carefully when transporting or installing it.
 - ▶ To avoid contamination, cover the inlet aperture with the alignment tool provided.
-

8 Installation/Removal

8.1 Prepare installation

1. Turn off the laser source.
2. Ensure that moving parts, e.g. robot arms, etc. are at a standstill and that they cannot be set in motion unintentionally.



DANGER

Serious eye or skin injury due to laser radiation

If the stability of the device is not ensured or the inlet aperture is not centered and mounted perpendicular to the laser beam, increased scattered or directed reflection of the laser beam will occur.

- ▶ Align the device as described in chapter 8.3 on page 16.
- ▶ Install the device according to chapter 8.4 on page 18 in a way that ensures, that the device can not shift or fall.

NOTICE

Damaging/Destruction of the device

Contamination and fingerprints on the protective window can lead to damage or shattering or splintering of the protective window during measuring operation.

- ▶ Do not touch the protective window.
- ▶ Only operate the device with a clean protective window.

8.2 Mounting position

The Cube M can be mounted vertically or horizontally.

8.3 Align the device

The device must be aligned to the laser beam. The laser beam must hit the inlet aperture in the middle. Please mind and adhere to the specifications and limit values given in chapter 19, „Technical data“, on page 50.

The device is positioned above the focus (see Fig. 8.1 on page 16). Make sure that the laser beam is convergent and the maximum permissible power density at beam entrance is not exceeded. The focal position of the laser beam must be located on the lower edge of the device.

To align the device under the laser, a alignment tool is included (see chapter 8.3.1 on page 17).

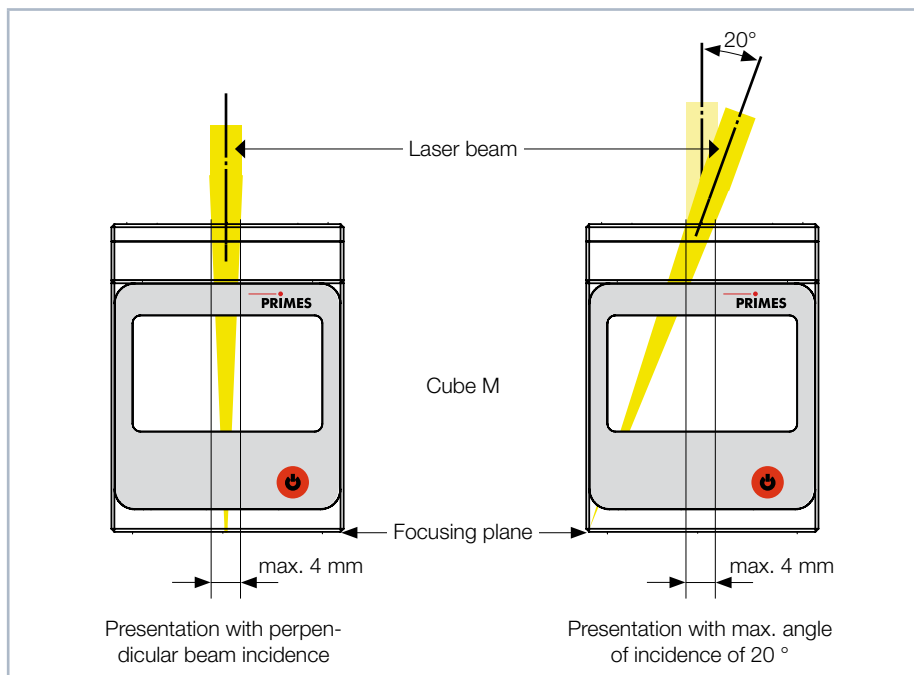

Fig. 8.1: Alignment to the laser beam

8.3.1 Align the device with the alignment tool

Using the alignment tool and a pilot laser beam, you can position the device with the necessary accuracy (see Fig. 8.2 on page 17).

1. Put the alignment tool on the inlet aperture.
2. Turn on the pilot laser and align the device:
 - If the laser beam hits the little marking in the alignment tool, the device is aligned.

NOTICE

Damaging/Destruction of the device

The exposure with laser radiation will destroy the alignment tool and the underlying protective window.

- ▶ Remove the alignment tool before measurement.

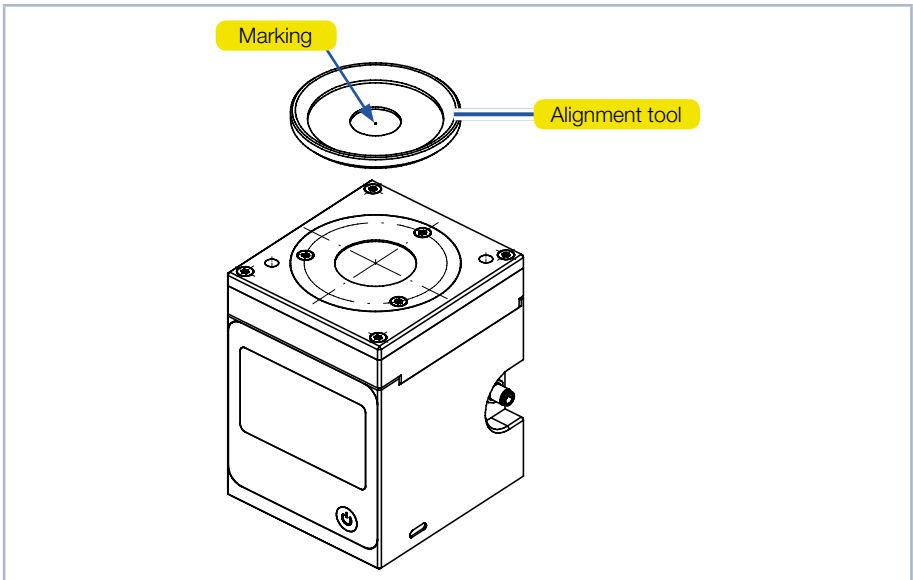

Fig. 8.2: Alignment of the device using the alignment tool

8.4 Install the device

1. Align the device with the laser beam as described in chapter 8.3 on page 16 and Fig. 8.1 on page 16.
2. Install the device with the mounting threads as shown in Fig. 8.3 on page 18.
3. Ensure a stable installation of the device:
 - The device must not be able to move.
4. Connect the safety interlock connection cable.
5. Remove the alignment tool from the protective window of the device.

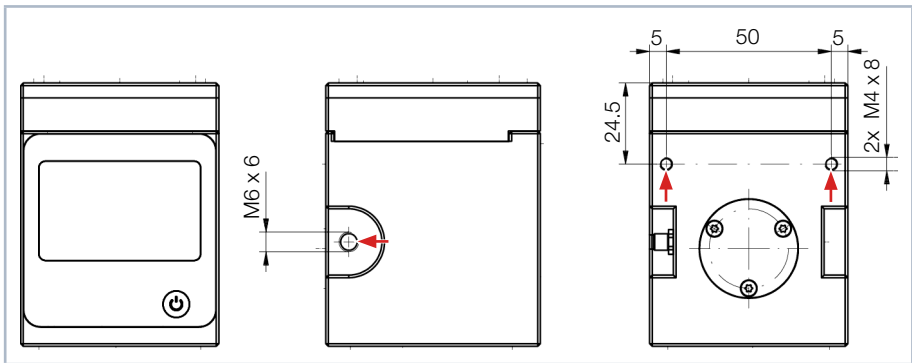

Fig. 8.3: Mounting threads in the housing

8.5 Remove the device

1. Turn off the laser source.
2. Ensure that moving parts, e.g. robot arms, etc. are at a standstill and that they cannot be set in motion unintentionally.
3. Unscrew the mounting screws from the mounting threads (see Fig. 8.3 on page 18).
4. Remove the safety interlock connection cable and remove the device from the laser system.
5. Apply the alignment tool to prevent contamination of the protective window.

9 Connections



Fig. 9.1: Connections

9.1 Safety interlock

The use of the safety interlock protects the device from damage in many situations. Nevertheless, depending on the parameters of the laser beam to be measured, damage to the absorber may occur. Please observe the specifications and limit values given in chapter 19, „Technical data“, on page 50.

During irradiation, the temperature of the absorber can rise significantly above 100 °C for a short time because the heat has not yet been distributed evenly in the absorber. To avoid triggering the safety interlock during irradiation in this case, the safety interlock is only triggered at a temperature above 200 °C when irradiation is in progress.

Therefore, when a running irradiation is detected, the interlock threshold is temporarily increased from 100 °C to 200 °C. After the end of the irradiation, the interlock threshold is reduced again to 100 °C.

If the temperature of the absorber is above 100 °C after the measurement is completed, the safety interlock is triggered to protect the absorber. This prevents the device from being irradiated again.

Pin 3 and pin 4 are connected when a safety interlock is triggered. After the absorber has cooled down, pin 1 and pin 4 of the safety interlock are connected.

Please observe the information on minimum and maximum energy input per measurement according to chapter 12.2.3 on page 28.

A suitable 2 m long connection cable is included.

NOTICE

Damaging/Destruction of the device

If the safety interlock is not connected, the device can be damaged or destroyed due to overheating.

- ▶ When connecting the laser control, please ensure that the laser is turned off in case of an interruption of the connection.

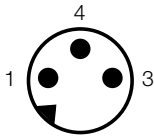
Pin diagram safety interlock plug (view connector side)	Pin	Wire color	Function
	4	Black	Mutual pin
	1	Brown	Connected with pin 4, when ready for operation
	3	Blue	Connected with pin 4, when in safety interlock mode (absorber too hot)

Tab. 9.1: Pin assignment of the safety interlock plug

9.2 Micro-USB socket

You can charge the battery of the device on the PC via the micro USB socket. Only use the supplied USB cable to charge the battery.

When using the optional LaserDiagnosticsSoftware LDS (not included in delivery), the device communicates with the LDS via the micro-USB socket or Bluetooth.

You will find the PRIMES USB-driver for all USB-capable devices on the PRIMES web-site at: <https://www.primes.de/en/support/downloads/software.html>.

9.3 Bluetooth

A class 1 Bluetooth interface is integrated in the device. This enables a wireless connection with the PC, tablet or the smartphone. When connected to a PC with a class 1 Bluetooth stick, the range under free space conditions is approx. 100 m. After switching on the device, the Bluetooth connection is permanently active. When the Bluetooth connection is activated, the USB interface is deactivated. However, simultaneous charging of the battery via the USB cable is possible.

When using the optional Cube App for mobile devices with Android™ (not included in delivery), the device communicates with the app via Bluetooth. The Cube App is available for free in Google Play-Store/Apps.

10 Functions of the On/Off button

The on/off button has several functions:

	Keystroke	Function
	Short press	Turn on
	5 seconds	Turn off
	2 seconds	Show measuring values
	Press again for 2 seconds	Turn over measuring value display

Tab. 10.1: Functions of the On/Off button

11 Displays on the device

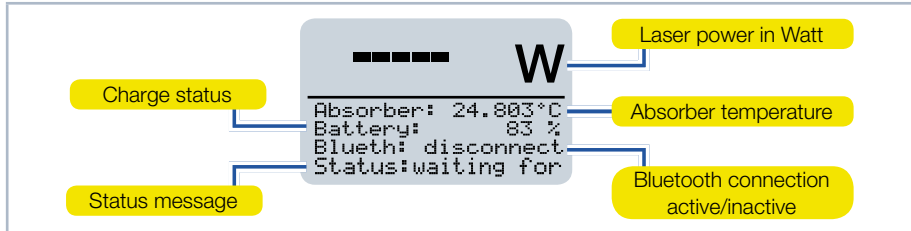

Fig. 11.1: Displays on the device

11.1 Status messages

Status message	Meaning
Waiting for laser beam	The device is ready for operation, the laser can be turned on.
Check temp.	The temperature gradient (change in the absorber temperature/time) is checked. Please wait until the message disappears. Thereafter, the device is ready to measure again.
Thermalize	The thermalization time allows for a uniform temperature distribution in the absorber. Afterwards, the temperature is measured.
Finished	The measurement is completed.

Tab. 11.1: Status messages

11.2 Warning message

Warning message	Reason
Safety interlock open	The absorber temperature has exceeded 100 °C. In order to protect the device, the safety Interlock is switched to the impermissible operating status.

Tab. 11.2: Warning message



This warning message does not imply an error. The message is automatically reset as soon as the absorber temperature is below 100 °C again. The safety interlock is then also automatically switched back to the permissible operating status.

11.3 Charge status of the lithium-ion battery

The charge status of the battery is displayed in percent. The accuracy of this display depends on various factors (e.g. temperature, age of the battery, etc.). Recharge the battery when the charge level reaches 20 percent.

The battery can be charged with a max. charging current of 1.3 A. The battery has a capacity of 1 000 mAh. The charging time of the battery on the PC via USB connection with a charging current of 500 mA is approx. 2 hours.

At 100 % charge status, the possible operating time is approx. 6 hours (equivalent to approx. 100 measurements). When using all power saving functions (see chapter 14.4 on page 37) approx. 15 hours.

12 Important information for measuring with the Cube M

12.1 Safety instructions



DANGER

Serious eye or skin injury due to laser radiation

If the stability of the device is not ensured or the inlet aperture is not centered and mounted perpendicular to the laser beam, increased scattered or directed reflection of the laser beam will occur.

- ▶ Install the device according to chapter 8.4 on page 18 in a way that ensures, that the device can not shift or fall.
-



DANGER

Severe eye or skin injury due to laser radiation

During the measurement the laser beam is guided on the device, which causes scattered or directed reflection of the laser beam (laser class 4). The reflected beam is usually not visible.

- ▶ Please wear safety goggles adapted to the power, power density, laser wave length and operating mode of the laser beam source in use.
 - ▶ Wear suitable protective clothing and protective gloves.
 - ▶ Protect yourself from laser radiation by separating protective devices (e.g. by using appropriate shielding).
-

NOTICE

Damaging/Destruction of the device

The maximum permissible energy per laser pulse depends on various variables, including the absorber temperature.

- ▶ Please observe the limit values and dependencies specified in chapter 19, „Technical data“, on page 50 before the measurement.
-

NOTICE**Damaging/Destruction of the device**

Contamination and fingerprints on the protective window can lead to damage or shattering or splintering of the protective window during measuring operation.

- ▶ Do not touch the protective window.
 - ▶ Regularly check the condition of the protective window and exchange it in case of pollution (see chapter 16.1, „Exchanging the protective window on the device“, on page 45).
 - ▶ Only operate the device with a clean protective window.
-

12.2 Laser parameter setting

12.2.1 Setting the laser rise time

The applicable measurement time is between 0.1 s and 2.0 s, which has to be transferred to the laser controller as pulse length. The maximum laser rise time for measuring the power cannot exceed $100\ \mu\text{s}$. This limit has to be adhered to in order to avoid incorrect results of the power measurement.

Some laser beam sources are factory set with power ramps of up to a few 100 ms to switch on the laser beam. To achieve a high measuring accuracy the shortest possible rise time has to be set.

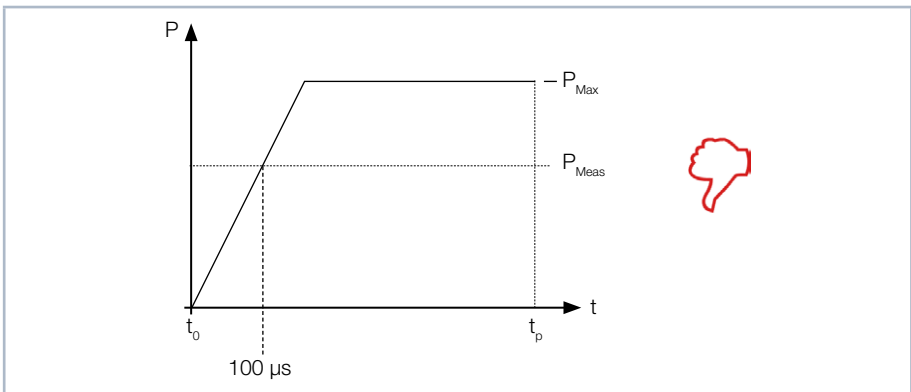

Fig. 12.1: Laser rise time $> 100\ \mu\text{s}$

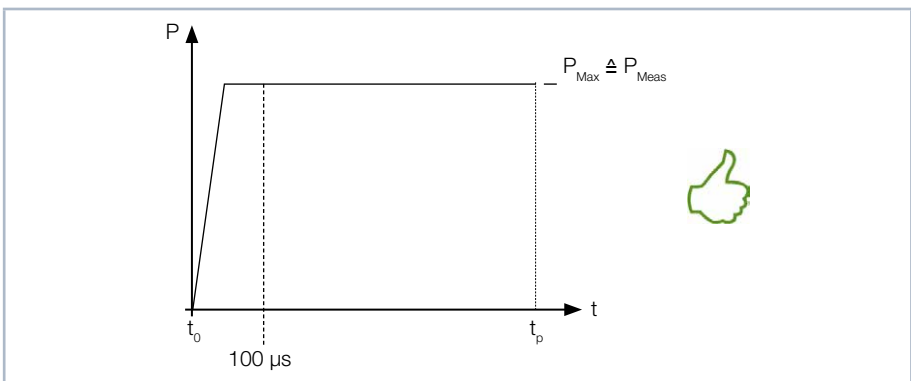

Fig. 12.2: Laser rise time $< 100\ \mu\text{s}$

12.2.2 Maximum permissible power density

To avoid damage to the optics, the maximum permissible power density of 250 kW/cm² at the optics must not be exceeded.

The power density in kW/cm² is calculated according to the formula:

$$Power\ density = \frac{P_{\text{Laser power in kW}}}{\pi \cdot r^2_{\text{Beam radius in cm}}}$$

Formula 1: Calculation of the power density

To determine the maximum laser power, the result is weighted with a safety factor of 2. The safety factor compensates the ratio of maximum to average power density.

$$P_{\text{Laser power in kW}} = max.\ Power\ density \frac{kW}{cm^2} \cdot \pi \cdot r^2_{\text{Beam radius in cm}} \cdot 0,5$$

Formula 2: Calculation of the permissible laser power depending on the beam diameter

The minimum permissible beam diameter in cm depending on the permissible power density and laser power is calculated according to the formula:

$$r_{\text{Beam radius in cm}} = \sqrt{\frac{P_{\text{Laser power in kW}}}{max.\ Power\ density \frac{kW}{cm^2} \cdot \pi \cdot 0,5}}$$

Formula 3: Calculation of the minimum permissible beam diameter depending on the permissible power density and the laser power

Example: With the maximum permissible power density of 250 kW/cm² at the optics and a laser power of 2 kW (only for devices with advanced absorber), the minimum permissible beam diameter is calculated as follows:

$$r_{\text{Beam radius in cm}} = \sqrt{\frac{2\ kW}{250 \frac{kW}{cm^2} \cdot \pi \cdot 0,5}} = 0,071\ cm = 0,71\ mm$$

Fig. 12.3: Example calculation

12.2.3 Minimum and maximum energy input per measurement

The measured temperature rise in the absorber is decisive for an accurate and reproducible measurement. Regardless of the starting temperature, we recommend an energy input of approx. 300 J per measurement.

Example: At 1 kW laser power the recommended pulse length is 300 ms.

$$E = P \cdot t = 1\,000\text{ W} \cdot 0.3\text{ s} = 300\text{ J}$$

Fig. 12.4 on page 28 shows information for selecting the energy permissible for a measurement in conjunction with the absorber temperature.

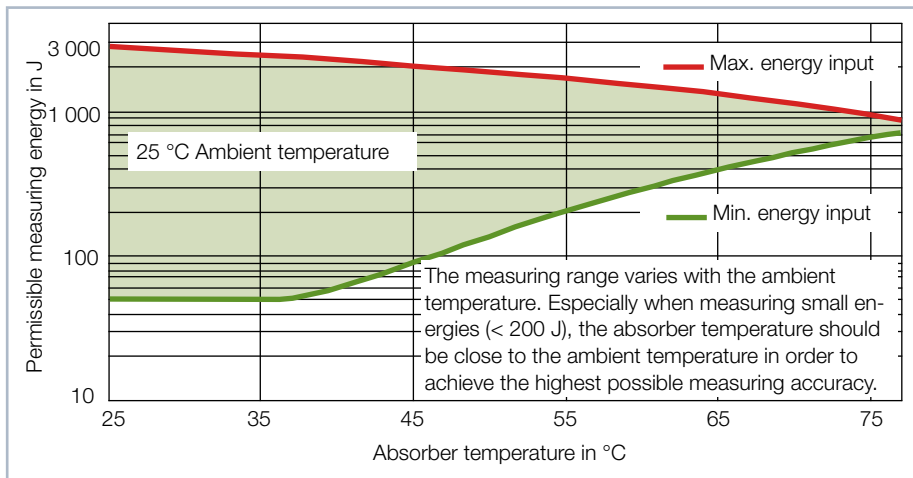

Fig. 12.4: Measuring range as a function of the absorber temperature

The minimum energy input indicates the lower limit values with which measurements can still be performed within the specified accuracy. The maximum energy application value specifies the limit at which the absorber reaches its permissible limit temperature. The energy, e.g. for multiple measurements (series measurements) can be distributed across the range shown in green.

If the absorber temperature is greater than 70 °C, it won't be possible to take any further measurements. In this case, please wait until the absorber temperature has fallen below 50 °C (depending on the selected energy input). Please take the limit values from Fig. 12.4 on page 28 and Tab. 12.1 on page 29.

Absorber temperature in °C	Min. energy input in J	Max. energy input in J
20	50	3 000
25	50	2 800
30	50	2 600
35	50	2 400
40	60	2 200
45	90	2 100
50	140	1 900
55	200	1 700
60	290	1 500
65	390	1 300
70	520	1 100

Tab. 12.1: Absorber temperature with the recommended minimum and permissible maximum energy input (ambient temperature 20 °C)

12.3 Waiting times until the next measurement in a measurement series

Please note that at high measuring frequencies the measuring accuracy may be limited. For serial measurements within the specified accuracy, we recommend the following waiting times until the next measurement.

Energy input in J	Maximum repetition rate in s
50	40
100	50
200	60
1 000	240

Tab. 12.2: Waiting times until the next measurement in series measurements

12.4 Measurement with pulsed lasers

When it comes to pulsed laser radiation a correct exposure time measurement up to a pulse frequency of 10 kHz and a duty cycle of 50 % is possible. In case of on/off times shorter than 50 μ s a correct exposure time measurement is not possible.

With pulsed lasers, the device recognizes the number of pulses n and the number of pulse pauses $n-1$. Since the last pulse pause t_{off} is not measured for technical reasons and this would lead to an increased display of the average power with a low number of pulses, the average power is corrected on the basis of the corrected burst duration (see Fig. 12.5 on page 30).

For cw lasers respectively one pulse, the average power corresponds to the maximum power of one pulse.

When measuring pulsed lasers, which have an oscillating switch-on and switch-off behavior, incorrect measurements of the number of pulses can occur. However, these incorrect measurements have no effect on the calculated average laser power and energy.

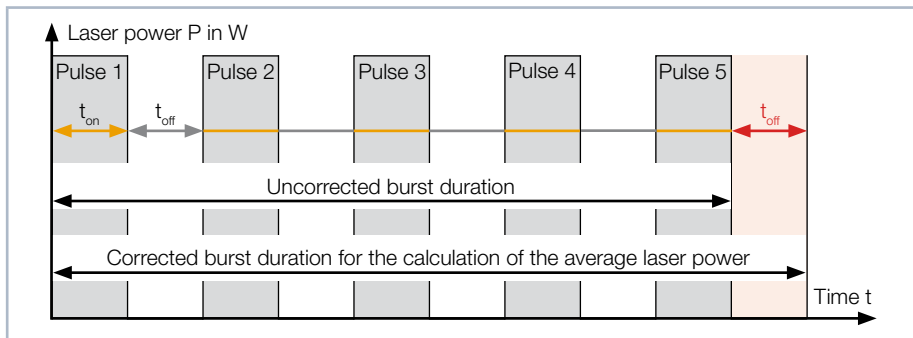





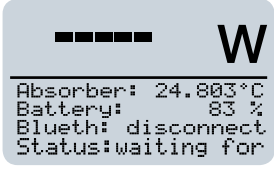

Fig. 12.5: Uncorrected and corrected burst duration with pulsed lasers

13 Measuring with the Cube M

Please read chapter 12, „Important information for measuring with the Cube M“, on page 24 first.

13.1 Start measurement

Measurements with the Cube M should be performed exclusively with a static (motionless) laser beam.

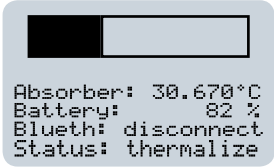
<ol style="list-style-type: none"> 1. Observe the safety instructions in chapter 12.1 on page 24. 	
<ol style="list-style-type: none"> 2. Press the on/off button. 	
<p> The start menu appears.</p>	
<p> After approx. 5 seconds, the device is ready for operation.</p>	
<ol style="list-style-type: none"> 3. Turn on the laser. <ul style="list-style-type: none"> • The measurement is started automatically when the the laser is switched on. 	<p>For a high measurement accuracy, we recommend an energy input of 300 J per measurement (see chapter 12.2.3 on page 28).</p>
<p> The thermalization is displayed by means of a progress bar (duration approx. 10 seconds). A measuring cycle (measure, thermalize, send data) takes approx. 15 seconds. The device is then ready for a new measurement.</p>	

 The window displays the following measurement values:

- Laser power in W¹⁾
- Absorber temperature in °C
- Corrected burst duration in ms (Time)

¹⁾ **The max. power of the laser is displayed in W (Pk Pow). The average power of a pulse is displayed in W (Av Pow).**

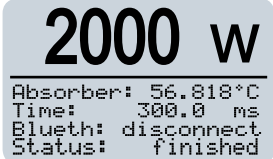

2000 W
 Absorber: 56.818°C
 Time: 300.0 ms
 Bluetooth: disconnect
 Status: finished

4. To access the following window, press the on/off button for approx. 2 seconds.



 For a pulsed laser the measured values of the pulse parameters are displayed:

- Total pulse duration in ms (Ontime)
- Total pulse pause in ms (Offtime)
- Uncorrected burst duration in ms (uBurst)
- Number of pulses (Pulses)
- Max. Power of a pulse in W (Pk Pow)
- Average power in W (Av Pow)
- Energy in J

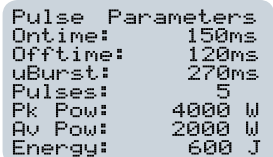

Pulse Parameters
 Ontime: 150ms
 Offtime: 120ms
 uBurst: 270ms
 Pulses: 5
 Pk Pow: 4000 W
 Av Pow: 2000 W
 Energy: 600 J



Further information on measuring with pulsed lasers can be found in chapter 12.4 on page 30.

The device turns off automatically after approx. 10 minutes. The power-off time of the device can be set via the LaserDiagnosticsSoftware LDS (see chapter 14.4 on page 37).

You can also turn off the device manually by keeping the on/off button pressed for approx. 5 seconds.

13.2 Measuring results display

The last 14 measuring values can be read off from the display of the Cube M. You can read off the last 30 measuring values with the optional Android™ PRIMES Cube App for mobile devices or optional LaserDiagnosticsSoftware LDS.

<ol style="list-style-type: none"> Press the on/off button for approx. 2 seconds. 																									
<p> The measured laser power (Power) and pulse duration ¹⁾ (Time) are displayed.</p> <ol style="list-style-type: none"> Press the on/off button again for 2 seconds to have the remaining measuring values (no. 8-14) displayed. <p>¹⁾ For cw lasers, the average power of the laser is displayed in W (Power) over the irradiation duration. For pulsed lasers, the average power of the laser is displayed in W (Power) over the corrected burst duration in ms (Time).</p>	<table border="1" style="background-color: #e0e0e0;"> <thead> <tr> <th>Nr</th> <th>Power</th> <th>Time 1</th> </tr> </thead> <tbody> <tr><td>1</td><td>2000.0</td><td>300.0</td></tr> <tr><td>2</td><td>912.1</td><td>333.4</td></tr> <tr><td>3</td><td>812.2</td><td>375.3</td></tr> <tr><td>4</td><td>712.5</td><td>428.9</td></tr> <tr><td>5</td><td>611.8</td><td>500.3</td></tr> <tr><td>6</td><td>511.1</td><td>600.4</td></tr> <tr><td>7</td><td>408.0</td><td>750.3</td></tr> </tbody> </table>	Nr	Power	Time 1	1	2000.0	300.0	2	912.1	333.4	3	812.2	375.3	4	712.5	428.9	5	611.8	500.3	6	511.1	600.4	7	408.0	750.3
Nr	Power	Time 1																							
1	2000.0	300.0																							
2	912.1	333.4																							
3	812.2	375.3																							
4	712.5	428.9																							
5	611.8	500.3																							
6	511.1	600.4																							
7	408.0	750.3																							

14 Measuring with the optional LaserDiagnosticsSoftware LDS

This chapter aims to provide some basic information as you get to know the Cube M, discussing the example of a measurement with the LaserDiagnosticsSoftware LDS. For a detailed description of the software installation, file management and evaluation of the measured data, please refer to the separate operating manual LaserDiagnosticsSoftware LDS.

Please read chapter 12, „Important information for measuring with the Cube M“, on page 24 first.

14.1 Notes of the LaserDiagnosticsSoftware LDS during measurement

If problems occur during a measurement, the LaserDiagnosticsSoftware LDS displays them in different categories and different colors.

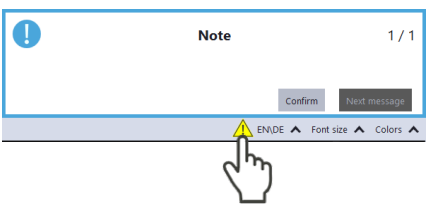
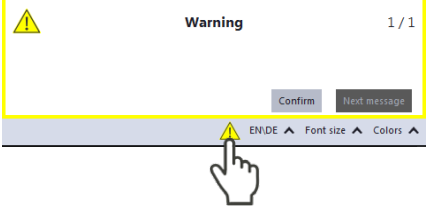
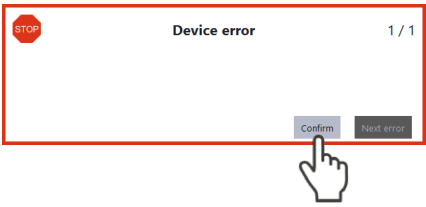
<p>Notes</p> <p>Notes provide assistance in interpreting the measurement results and are displayed in a blue window.</p> <p>By clicking on the warning triangle in the footer, further information about the problem is displayed.</p>	
<p>Warnings</p> <p>Non-safety-critical problems that influence the quality of the measurement results, for example, are displayed in a yellow window.</p> <p>By clicking on the warning triangle in the footer, further information about the problem is displayed.</p>	
<p>Safety critical device errors</p> <p>Safety-critical problems that can result in damage/destruction of the device are displayed in a red window.</p> <p>Safety-critical problems must be resolved immediately. The safety-critical message must be confirmed to continue the measurement.</p>	

14.2 Connect the Cube M to the LaserDiagnosticsSoftware LDS

1. Connect the USB cable to the Micro-USB socket on the device and with the PC (see Fig. 9.1 on page 19) or activate the Bluetooth function on the PC. When the Bluetooth connection is activated, the USB interface is deactivated.

2. Press the on/off button on the device.



3. Start the LaserDiagnosticsSoftware LDS.

4. Click on the **Devices** tab.

5. Click on the **+ Connect to device** button under the tab.

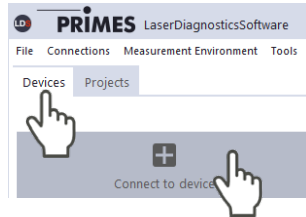

6. The **Connections** window appears.

7. Click on the desired device.

8. Click on the **Connect to device** button.

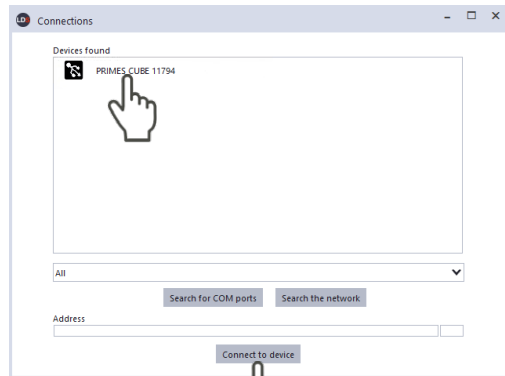



14.3 Open toolbench Cube measurement

 The Cube M is established as a connected device.

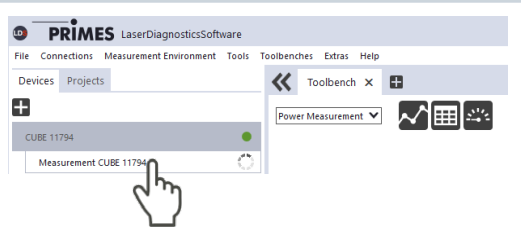
1. Click on the connected device.



 The corresponding **Device control** opens.

 The toolbench **Cube Measurement** is opened.

If the toolbenches have previously been closed, click the **Open measurement toolbench** button to open it again.

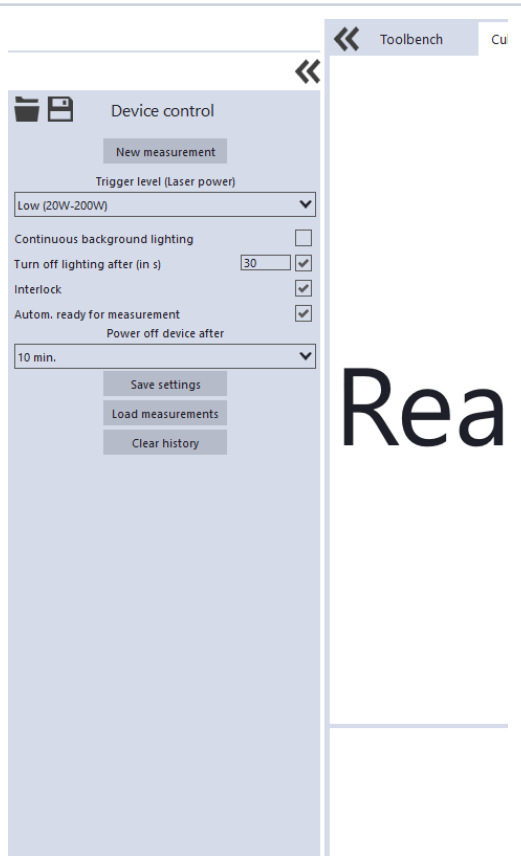

14.4 Settings for trigger level, power saving functions and automatic measurement readiness

The trigger level determines the sensitivity of the photodiode for laser detection. The trigger level Low is recommended for pulsed beams.

With a low trigger level a measurement may be triggered even without a laser beam. In this case set the trigger level to a higher value. The default setting for the Cube M is trigger level Low.

1. Set the **Trigger level (Laser power)**.
 - In the Cube M the default setting is the Trigger level **Low (20W-200W)**.
2. Click on the **Save settings** button.

In the LaserDiagnosticsSoftware LDS you can make additional settings for power saving functions and the automatic measurement readiness:

1. Enter the desired settings in the **Device control**.
2. Click on the **Save settings** button.

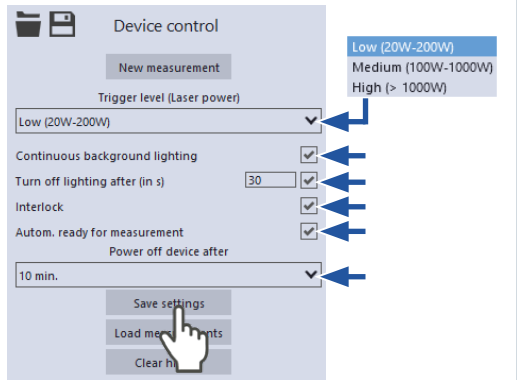

Autom. ready for measurement

By default, the device automatically returns to measurement readiness after each measurement. If you uncheck the box, you will need to reset the unit after each measurement by briefly pressing the on/of button.

Power Saving Function	Continuous background on/off
	Turn off lighting after (in s). The set time only applies if the permanent backlight is switched off.
	Switch the safety interlock on/off. For safety reasons switching off the safety interlock is not recommended.
	Switch off the device after a set time. The option to not switch off the device is only selectable when the charging cable is connected.

14.5 Start measurement

Measurements with the Cube M should be performed exclusively with a static (motionless) laser beam.

The measurement is started automatically when the laser is switched on. The display field **Start** is therefore not active.

A measuring cycle (measure, thermalize, send data) takes approx. 15 seconds. The device is then ready for a new measurement.

If you have previously displayed a measurement in the toolbench, press the **New measurement** button.

If the setting **Autom. ready for measurement** (see chapter 14.4 on page 37) is deactivated, briefly press the on/off button on the device.



1. Observe the safety instructions in chapter 12.1 on page 24.
2. Turn on the laser.

 The progress of the measurement is indicated in the **Measurement is running** and then **Measurement is finished** displays.

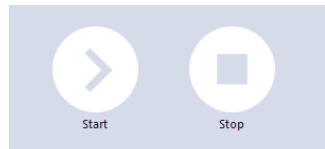
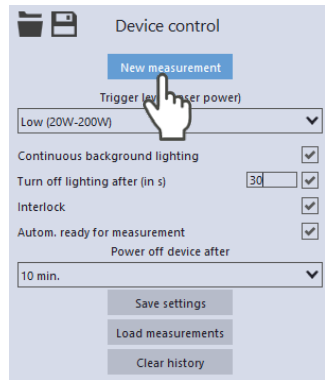
3. Turn off the laser.





Status

-  Ready for measurement
-  Measurement is running
-  Measurement finished

14.6 Measuring results display

14.6.1 Display the current measurement in the toolbench Cube measurement

 The measuring results are displayed in the opened toolbenches once the measurement has been completed (see below).

By clicking on the gear symbol  you can adjust the displayed parameters.

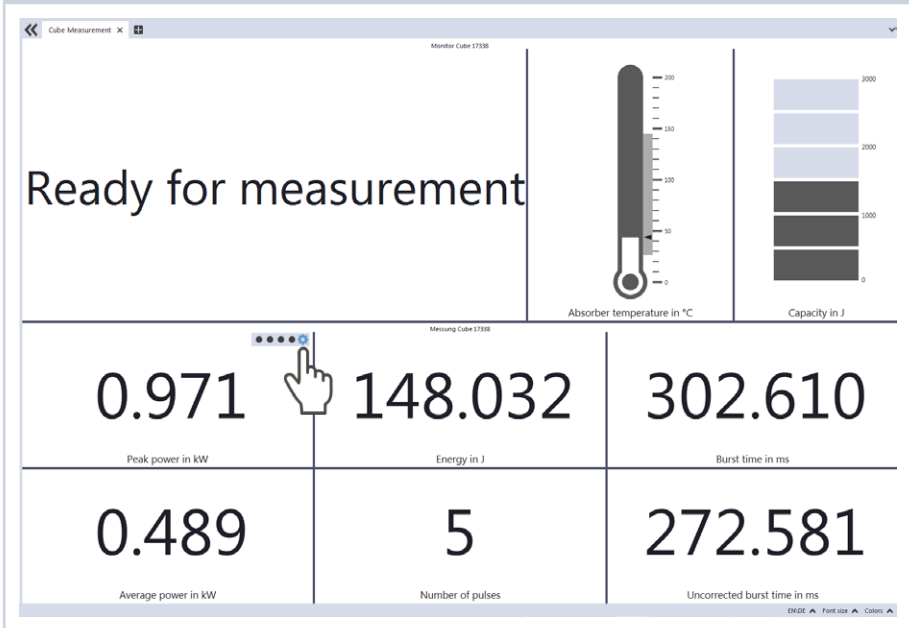

14.6.2 Display of the measurements stored in the Cube M

1. Press the **Load measurements** button
 - The last 30 measured values stored in the device are read out of the memory of the Cube M.

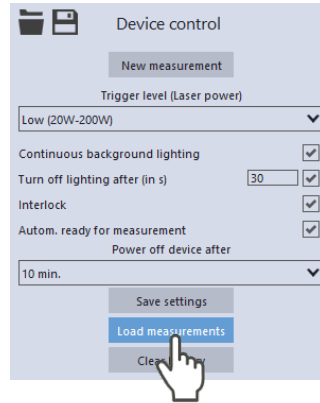

2. Switch to the **Projects** tab.
 - In the project tree the read out measured values are displayed.

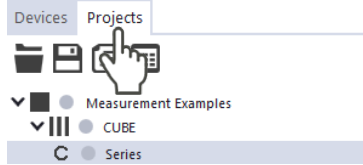

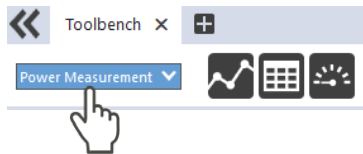

3. Click on the **Power Measurement** selection in the drop-down list below the Toolbench.

- The tools **Graph**, **Results Table** and **Measurement Value Display** are displayed.



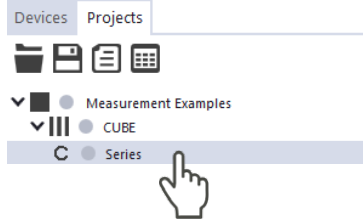

4. Open the desired tool and drag and drop the measured values from the project tree into the opened tool.



By clicking on the gear symbol  you can adjust the displayed parameters.

Toolbench × +

Power Measurement ▾



Results Table: Power measurement

	0	1	2	3	4
Energy in J	199.638	455.742	455.522	456.146	488.911
Number of pulses	1	5	5	5	6
Uncorrected burst time in ms	100.249	272.445	272.429	272.401	272.797
Burst time in ms	100.249	302.638	302.636	302.605	302.97
Average power in W	0	1505.901	1505.182	1507.397	1613.727
Peak power in kW	1.991	3.005	3.005	3.009	4.01

Measurement Val...

1656.389

Capacity in J

Graph: Power measurement

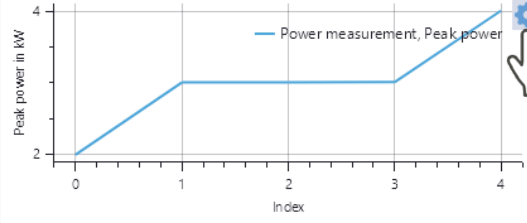

42

Revision 11 EN - 03/2021

14.7 Delete measured values from the memory of the Cube M

The Cube M stores the measured values in an internal memory. The measured values can be displayed and deleted with the LaserDiagnosticSoftware LDS.

1. Click on the **Clear history** button.
 - The measured values in the Cube M are deleted.

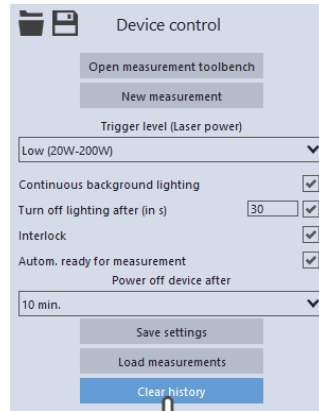

15 Measuring with the optional Cube App

With the Cube App for mobile devices with Android™ you can operate and evaluate the device via a smartphone/tablet.

The Cube app is available free of charge in the Google Play Store/Apps. You need a valid Google account. In the search field of the Google Play Store, enter the search term “Primes cube app”.

A Bluetooth connection with the device makes it possible to read out and graphically display the measured values (laser power, pulse length, and energy per pulse) with the mobile end device. The Cube App also shows an overview of the device status (temperature, charge status, status notifications).

In the Cupe App you can make additional settings for power saving functions and the automatic measurement readiness (see Tab. 15.1 on page 44).

Function	Possible settings
Autom. ready for measurement	By default, the device automatically returns to measurement readiness after each measurement. If you uncheck the box, you will need to reset the unit after each measurement by briefly pressing the on/off button.
Power Saving Function	Continuous background on/off
	Turn off backlight after (in s). The set time only applies if the permanent backlight is switched off.
	Switch the safety interlock on/off. For safety reasons switching off the safety interlock is not recommended.
	Switch off the device after an entered time. The option to not switch off the device is only selectable when the charging cable is connected.

Tab. 15.1: Functions and settings

Please find detailed information on the operation of the Cube App in the separate operating manual Cube App. These can be found on the PRIMES website at: <https://www.primes.de/en/support/downloads/operating-manuals.html>.

16 Maintenance and service

The operator is responsible for determining the maintenance intervals for the measuring device.

PRIMES recommends a maintenance interval of 12 months for inspection and calibration.

If the device is used only sporadically, the maintenance interval can be extended up to 24 months.

16.1 Exchanging the protective window on the device

The protective window in the beam entrance is a wearing part and can be replaced if necessary. Low levels of contamination of the protective window can be removed carefully with Isopropanol when cooled down (observe the manufacturer's safety instructions). In case of heavy, non-removable contamination or damage, the protective window must be replaced with a new one.



The protective window is coated with an anti-reflective coating and has low reflectance values of less than 1 %. To avoid increased reflectance values, use only original PRIMES protective windows.

Protective window diameter 30 mm

Glass thickness 1.5 mm

Order number 801-004-054 (1 piece); 410-011-022 (10 pieces)

16.1.1 Safety instructions



DANGER

Severe eye or skin injury due to laser radiation

If the protective window is not correctly positioned, reflections can cause directional laser radiation.

- ▶ **Ensure that the new protective window is positioned evenly in the indentation on the O-ring.**

**CAUTION**

Burns due to hot components

After a measurement the optics below the protective window is hot! Unintentional contact during the protective window exchange could lead to burns.

- ▶ Do not replace the protective window directly after a measurement.
 - ▶ Let the device cool down for an adequate period of time. The cooling time varies depending on the laser power and the irradiation time.
-

NOTICE

Damaging/Destruction of the device

Contamination and fingerprints on the protective window can lead to damage or shattering or splintering of the protective window during measuring operation.

- ▶ Only replace the protective window in a dust-free environment.
 - ▶ Do not touch the protective window.
 - ▶ When exchanging the protective window wear powder-free latex gloves.
-

NOTICE

Damage to the optics

Pollution on the optics surface causes measurement deviation during laser beam irradiation by means of absorption and can damage the optics.

- ▶ Ensure during exchanging the protective window that the subjacent optics will not be polluted.
-

16.1.2 Exchanging the protective window

1. Observe the safety instructions in chapter 16.1.1, „Safety instructions“, on page 45.
2. Unscrew the 3 Torx screws M2.5 x 4 mm on the protective window holder.
3. Place the device as shown in Fig. 16.1 on page 47 and carefully remove the protective window holder upwards.
 - Make sure that the inserted O-ring does not fall out of the device.
4. Remove the old protective window from the device and dispose it.
5. Wear powder-free latex gloves and insert the new protective window into the device.
 - Ensure that the inserted O-ring is not out of place.
6. Place the protective window holder according to Fig. 16.1 on page 47.
7. Tighten the protective window holder with 3 Torx screws M2.5 x 4 mm.
8. Check for secure fit of the protective window holder:
 - The protective window holder must lie flat on the device.

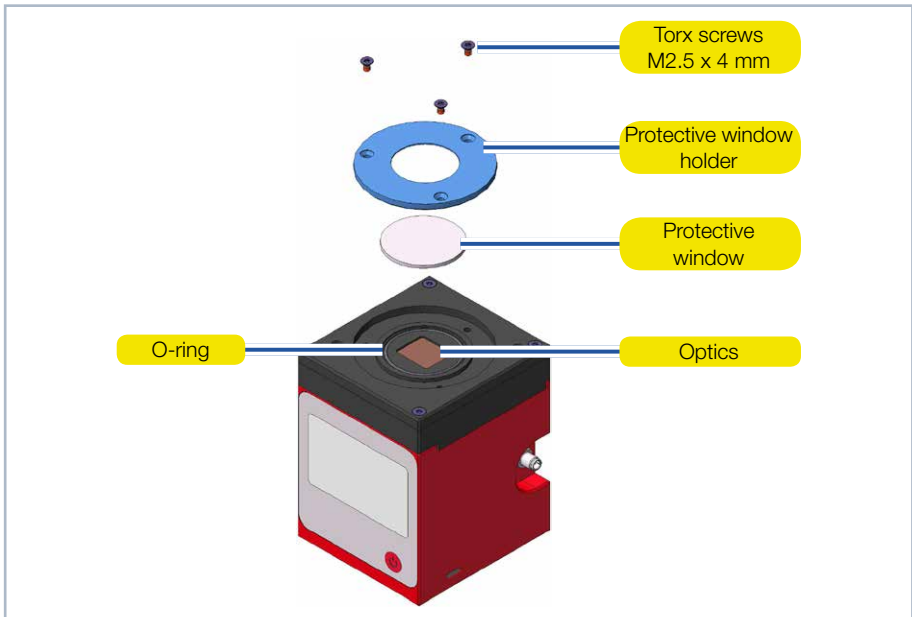

Fig. 16.1: Exchanging the protective window on the Cube M

17 Measures for the product disposal

PRIMES gives you the opportunity to return your PRIMES measuring device for free disposal within the scope of the Waste of Electrical and Electronic Equipment (WEEE Directive). You can send PRIMES measuring devices to be disposed of within the EU (this service does not include shipping costs) to our address:

PRIMES GmbH
Max-Planck-Str. 2
64319 Pfungstadt
Germany

If you are located outside the EU, please contact your local PRIMES distributor to discuss the disposal procedure for your PRIMES measuring device.

PRIMES is a registered manufacturer in the German "Used Appliances Register" stiftung elektro-altgeräte register (stiftung ear) with the number WEEE-reg.-no. DE65549202.

18 Declaration of conformity

Original EG Declaration of Conformity

The manufacturer: PRIMES GmbH, Max-Planck-Straße 2, 64319 Pfungstadt, Germany,
hereby declares that the device with the designation:

Cube

Types: Cube, Cube M, Cube L, Cube L1

is in conformity with the following relevant EC Directives:

- EMC Directive EMC 2014/30/EU
- Low voltage Directive 2014/35/EU
- Directive 2011/65/EC on the restriction of the use of certain hazardous substances (RoHS) in electrical and electronic equipment
- Radio Equipment Directive 2014/53/EU

Authorized for the documentation:

PRIMES GmbH, Max-Planck-Straße 2, 64319 Pfungstadt, Germany

The manufacturer obligates himself to provide the national authority in charge with technical documents in response to a duly substantiated request within an adequate period of time.





Pfungstadt, November 12, 2019



Dr. Reinhard Kramer, CEO

19 Technical data

Measurement parameters	Standard absorber ¹⁾	Advanced absorber ¹⁾
Power range	25 – 1 000 W ²⁾	25 – 2 000 W ²⁾
Wavelength range	1 030 – 1 090 nm	
Beam diameter on the protective window	1 – 4 mm	
Max. power density on the protective window	250 kW/cm ²	
Irradiation time	0.1 – 2.0 s ²⁾ (depending on laser power)	
Min. on/off times (duty cycle) for pulsed lasers	50 µs (e.g. max. 10 kHz at 50 % duty cycle)	
Max. laser rise time	100 µs	
Energy per measurement	50 – 3 000 J	
Recommended energy per measurement	300 – 500 J	
Total duration until measurement value output	< 15 s	
Nominal measurement frequency	300 J: 1 cycle/min 3 000 J: 1 cycle/15 min	
Device parameters	Standard absorber ¹⁾	Advanced absorber ¹⁾
Max. absorber temperature	120 °C	
Max. angle of incidence perpendicular to inlet aperture	± 20 °	
Max. centered tolerance	± 2.0 mm	
Accuracy		
Angle of incidence up to 5 °	± 3 %	
Angle of incidence from 10 ° to 20 °	± 5 %	
Reproducibility	± 1 %	
¹⁾ Please read the information on the identification plate to determine if your device is equipped with a standard or advanced absorber.		

	
	
When nothing is marked, a standard absorber is built into the device.	When an A marking is made, an advanced absorber is built into the device.
²⁾ The stated limit values are to be understood in correlation with the permitted maximum energy (E = P · t).	
Supply Data	
Power supply	Built-in lithium-ion battery
Maximum charging current	1.3 A
Voltage	3.7 V
Capacity	1 000 mAh
Energy	3.7 Wh
Weight of the battery	20 g
Shipment classification	Lithium ion batteries contained in equipment
Temperature range for charging the lithium-Ion battery	0 – 45 °C
Communication	
Interfaces	USB/Bluetooth
Dimensions and Weight	
Dimensions (LxWxH) (without connectors)	60 x 65 x 80 mm
Weight (approx.)	800 g
Environmental Conditions	
Operating temperature range	15 – 40 °C
Storage temperature range	5 – 50 °C
Reference temperature	22 °C
Permissible relative humidity (non-condensing)	10 – 80 %

20 Dimensions

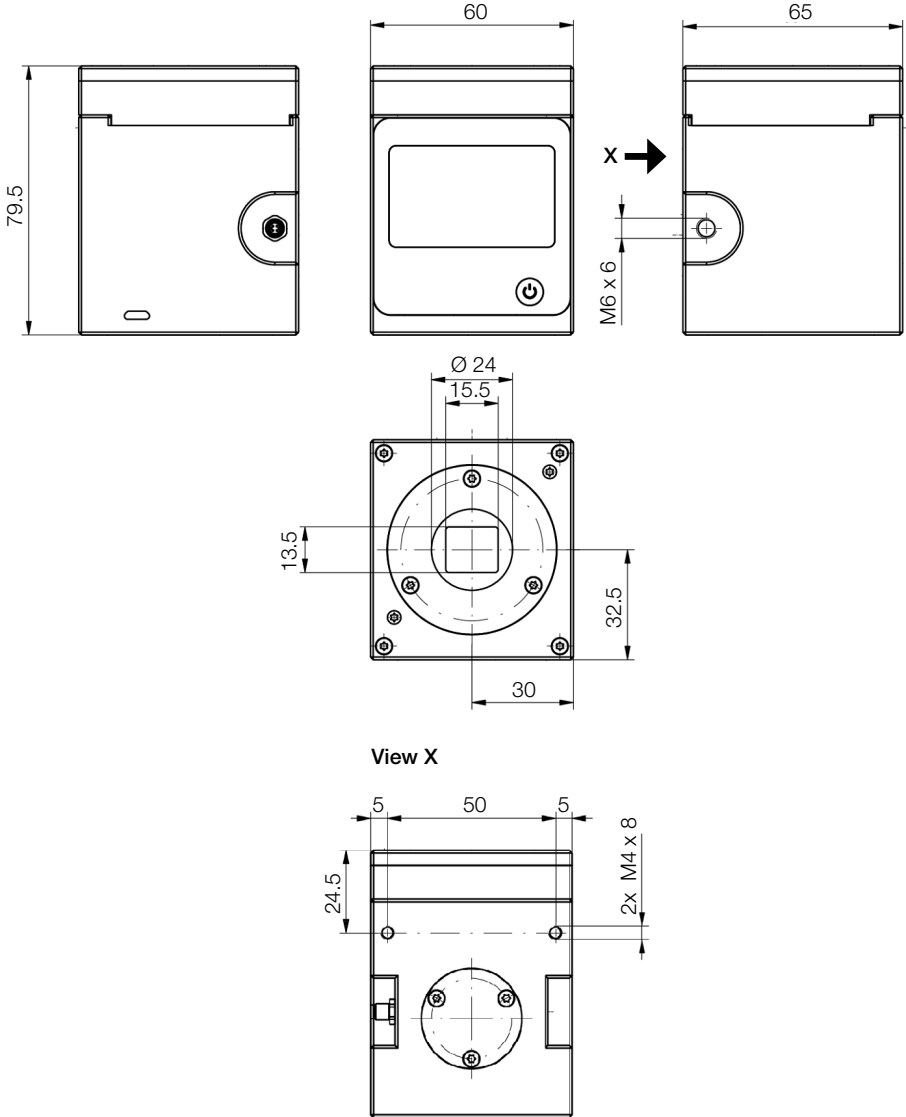

All dimensions in mm (general tolerance ISO 2768-v)

PRIMES GmbH
Max-Planck-Str. 2
64319 Pfungstadt
Germany

Tel +49 6157 9878-0
info@primes.de
www.primes.de